



Hydropool Standard Work Instructions

Signature Corner (w/ Stiffener Brace) Installation Instructions

Process Description: Signature Corner Bracket and Magnet Installation





Revised Date

16-Sep-25

Created by John Tumanguil

Approved by

Hydropool

ID#	Process name	Method
1	Parts	<div style="display: flex; justify-content: space-around;">   </div> <p>Hardware Kit: Part # PA25012 will include:</p> <ul style="list-style-type: none"> 1 - Part # 2005340: Signature Frame Corner Screw Boss Insert 2 - Part # 2005103: Magnetic Steel Plate 3 - Part # 2005166: Magnet 4 - Part # 2005339: Signature Cabinet Corner Magnet Bracket 5 - Part # 2015552: 10-12x7/8" Screw (x2) 6 - Part # 2015196: 8x9/16" Screw 8 - Part # 2005320: Signature Corner Spring Clip (x2) 9 - Part # 2010021: 8-18x3/4 Zinc Screw (x4) <p>Ordered Separately:</p> <ul style="list-style-type: none"> 7 - Signature Corner: Order new part number to match cabinet. <div style="display: flex; justify-content: space-between; margin-top: 10px;"> <div style="background-color: yellow; padding: 5px; border: 1px solid black;"> <p>Note -- Glue: You will need an Cyanoacrylate adhesive (not included), which is found in most crazy glues. Other adhesives will not bond.</p> </div> <div style="border: 1px solid black; padding: 5px;"> <p>Examples of adhesives:</p>  </div> </div> 

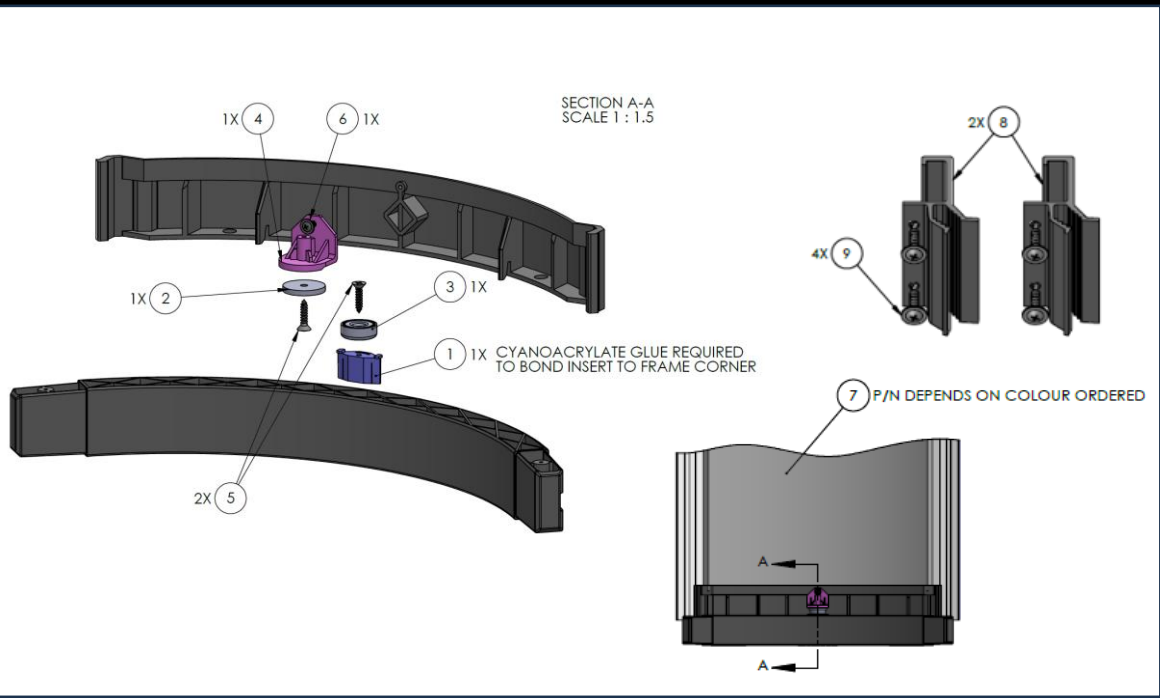
2	Overview	 <p>SECTION A-A SCALE 1 : 1.5</p> <p>1X 4 6 1X</p> <p>1X 2 3 1X</p> <p>2X 5</p> <p>1 1X CYANOACRYLATE GLUE REQUIRED TO BOND INSERT TO FRAME CORNER</p> <p>2X 8</p> <p>4X 9</p> <p>7 P/N DEPENDS ON COLOUR ORDERED</p>
----------	-----------------	---

Signature Corner (w/ Stiffener Brace) Installation Instructions

Process Description: Signature Corner Bracket and Magnet Installation

Revised Date

16-Sep-25

Created by John Tumanguil

Approved by

Hydropool

ID#

Process name

Method

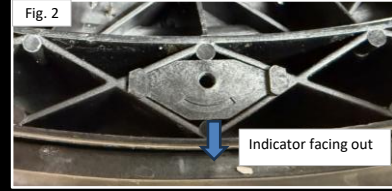
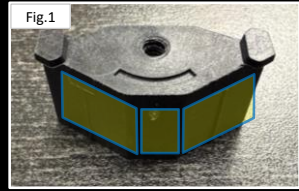
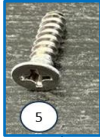
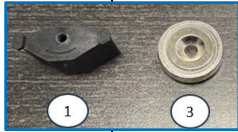

1. Apply glue to the outer surface of (1) all around. (Fig. 1)
2. Ensure (1) is in the correct orientation, with the indicator mark facing outwards. (Fig. 2)

2

Signature Frame Corner Screw Boss Insert Installation



3. Insert (1) into the center diamond slot of the corner frame until it bottoms out. This will be the 5th diamond slot. (Fig. 3)
4. Install (3) on to (1) using the screw (5). (Fig. 4)



3

Steel Plate Installation on to Corner Stiffener Brace

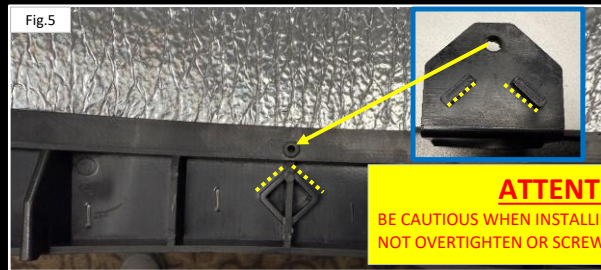

ATTENTION:
BE CAUTIOUS WHEN INSTALLING THE SCREW. DO NOT OVERTIGHTEN OR SCREW HOLE MAY STRIP.

5. Line up (4) to the corner stiffener brace (Fig. 5) and install using screw (6). (Fig. 6)



6. Install (2) on to (4) using screw (5).

Signature Corner (w/ Stiffener Brace) Installation Instructions

Process Description: Signature Corner Bracket and Magnet Installation

Revised Date

16-Sep-25

Created by
ID#

John Tumanguil
Process name

Approved by

Hydropool
Method



4

Frame
Corner Clip
Relocation

7. Remove all the existing corner clips. Install (8) (x2) at the top -- 1.6" from the bottom of the top frame, to the top of the corner clip using (9) (x2 per clip). (See Fig. 7)

5

Corner
Installation

For video instructions
please scan the QR
Code:



8. Tuck in the New Signature Corner (7).



9. Line up the corner by lining up the edge of the corner panel with the light rail part line.



10. Push the top of the corner to engage the the top corner clips.



11. Slide the corner down to engage the hooks and magnet.