

2023 HYDROPOOL AQUAPLAY COLLECTION

13FFP Model Swim Spa

INSTALLATION GUIDE



HYDROPOOL
hot tubs • swim spas

THE WATER IS CALLING



EFFECTIVE DATE: January 1, 2023 *(supersedes all others)*

CAUTION: THIS GUIDE IS FOR REFERENCE ONLY! All installations must follow local electrical and building codes. Please consult your local business and planning division for your codes in your area.

HYDROPOOL INC. WILL NOT BE RESPONSIBLE FOR ANY ERRORS IN INSTALLATIONS OR CODE INFRACTIONS.

2023 AQUAPLAY SWIM SPA COLLECTION INSTALLATION MANUAL

TABLE OF CONTENTS:

1. Types of installs	Page 1	Cross Section Side View of 2023 13FFP AquaPlay Swim Spa Install Inground	Page 13-14
1.1 Free Standing with Cabinet above ground		5.7 Service Access	Page 15
1.2 Free Standing in Deck with cabinet		5.8 Water Test	
1.3 Below Grade Indoor		5.9 Overall Support	
1.4 Below Grade Outdoor		5.10 Insulation	
2. Model, Specifications and Electrical	Page 2	5.11 Set Up and Assembly	
2.1 Model and Series		5.12 Equipment Protection	
Shell Dimensions and Weights for the 2023 13FFP AquaPlay Swim Spa		6. Serviceability, Accessibility and Protection	Page 16
2.2 Electrical Specifications	Page 3	6.1 Equipment Protection	
2.3 Wiring Size	Page 3	6.2 In Ground Installations	
2.4 North American GFCI Installation	Page 4	6.3 Serviceability	
2.5 European R.C.D. Installations	Page 5	6.4 Remote Equipment	
3. Delivery and Handling Considerations	Page 6	6.5 Rodent Protection	
3.1 Retailer Delivery		7. Filling and Draining	Page 17
3.2 Direct Deliveries		7.1 General Considerations	
3.3 Crane Deliveries		7.2 Indoor Installations	
3.4 Fork Lift Deliveries		7.3 Outdoor Installations	
3.5 Roller Deliveries		8. Auxiliary Heating Options	Page 17
3.6 Warnings		8.1 Gas Heaters	
4. Above Grade	Page 7	8.2 Other Methods	
4.1 Preparation		8.3 Auxiliary By Pass	
4.2 Concrete		9. Ventilation, Humidity Control, Other Indoor Considerations	Page 18
4.3 Rooftop / Balcony Install		9.1 Humidity Control	
4.4 IMPORTANT: Swim Spa Frame Shim Installation (Applies to All Installations)		9.2 Ventilation	
Cross Section Side View of 2023 13FFP AquaPlay Swim Spa Install Above Ground	Page 8	9.3 Hardcover	
Cross Section Topside View of 2023 13FFP AquaPlay Swim Spa Install Above Ground	Page 9	9.4 Floor Drainage	
5. Below Grade or Partial In Grade Installations	Page 10	10. Hardcover Storage	Page 19
5.1 Backfilling Exclusion		10.1 Hardcover	
5.2 Excavation		10.2 Pool Shed	
5.3 Vault/Bunker Specs		11. By Laws and Disclaimer	Page 19
5.4 Base of Support		11.1 Building Cod	
5.5 Crawl Space		11.2 Excavation	
5.6 Ground Water		11.3 Recommendations	
Cross Section Top View of 2023 13FFP AquaPlay Swim Spa Inground...	Page 11	11.4 Professionals	
Cross Section End View of 2023 13FFP AquaPlay Swim Spa Full & Partial Inground Installation	Page 12	11.5 Sunlight	
		Notes	Page 20

1. TYPES OF INSTALLATIONS:

1.1 FREE STANDING WITH CABINET ABOVE GROUND

This installation refers to a swim spa that is placed on a concrete pad, above ground and with a Hydropool Cabinet. Can be adjacent to a deck or butted up to a deck.



1.2 FREE STANDING IN DECK

This installation refers to a swim spa that is placed on a concrete pad, above ground and with a Hydropool cabinet. This swim spa is surrounded on 1 or 2 sides by deck.



1.3 BELOW GRADE OUTDOOR

This installation refers to a swim spa that is placed on a concrete pad, below grade with a Hydropool Cabinet. Can be partially or fully recessed in the ground.

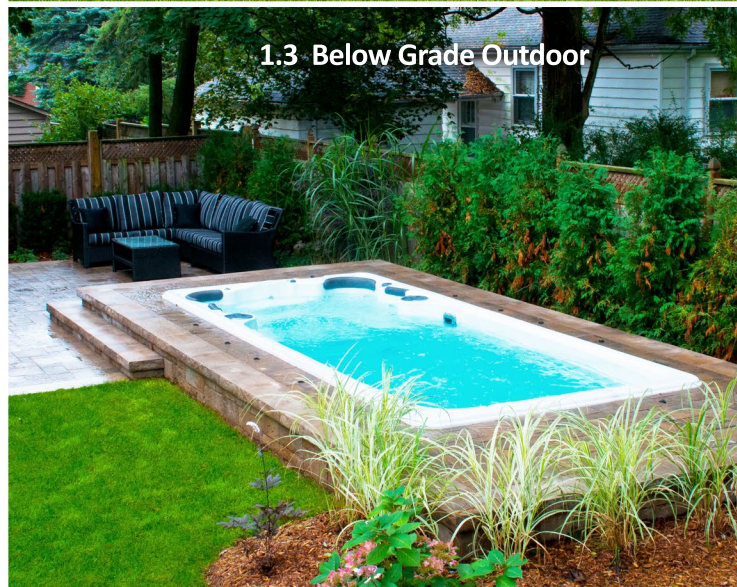

1.4 BELOW GRADE INDOOR

Indoor installations of a swim spa must be placed on a concrete pad. Swim spas can be partially or fully recessed in the floor.



2. MODEL SERIES, SPECIFICATION AND ELECTRICAL



2.1 **13FFP** AQUAPLAY SWIM SPA

MODEL SPECS.

SHELL DIMENSIONS:

150" x 93" /

381 cm x 236.2 cm

HEIGHT:

52.75" / 134 cm

VOLUME:

1,340 US Gallons /

5,092 Liters

WEIGHT FULL:

13,386 lbs / 6,073 kg

WEIGHT EMPTY:

2,163 lbs / 981 kg

SIZE CATEGORY: 12'

HYDROTHERAPY SEATING:

10 Persons

2.2 ELECTRICAL SPECIFICATIONS

SAFETY COMES FIRST. WHEN INSTALLING & USING ELECTRICAL EQUIPMENT, BASIC SAFETY PRECAUTIONS MUST ALWAYS BE FOLLOWED!

1. READ AND FOLLOW ALL INSTRUCTIONS

2. Electrical installation must be completed by a qualified electrician in accordance with all National, Regional and Local Codes and Regulations in effect at the time of installation.
3. Connect only to a dedicated circuit protected by a class 'A' two-pole ground fault circuit interrupter (GFCI)

Hydropool highly recommends the use of a new Siemens GFCI breaker for all of its products.

4. Use copper conductors only!
5. The swim spa equipment and all electrical plugs, outlets and lights within 1.5m (5ft) of the unit must be G.F.C.I protected. Consult your electrician or local electrical authority for further details.
6. A green colored terminal or a terminal marked "G", "GR", "Ground", or "Grounding" is located inside the supply terminal box or compartment. To reduce the risk of electric shock, this terminal must be connected to the grounding by means provided in the electric supply service panel with a continuous copper wire equivalent in size to the circuit conductors supplying the equipment.
7. At least two lugs marked "BONDING LUGS" are provided on the external surface or on the inside of the supply terminal box or compartment. To reduce the risk of electric shock, connect the local common bonding grid in the area of the swim spa to these terminals with an insulated or bare copper conductor not smaller than No.6 AWG (Canada/Europe) / No.8 AWG (USA).
8. All field installed metal components such as rails, ladders, drains or other similar hardware within 3 m (10 ft) of the swim spa shall be bonded to the equipment grounding bus with copper conductors not smaller than No.6 AWG.

2.3 WIRING SIZE

NORTH AMERICA / EUROPE WIRE SIZE

Please consult your applicable electrical codes related to the size of the breakers and the wire. Take into consideration the length of the cable and increase as required.

G.F.C.I./R.C.D. APPLICATION GUIDE FOR HYDROPOOL SWIM SPA SERIES

NORTH AMERICA

AquaPlay/AquaSport/Executive Sport 50A
AquaSport 19DTAX Gold (40A Spa / 50A Swim)
AquaTrainer/Executive Trainer 60A
AquaTrainer 19DTAX Gold (40A Spa / 60A Swim)

EUROPE (SINGLE PHASE)

AquaPlay/AquaSport/Executive Sport 40A
AquaSport 19DTAX Gold (20A Spa / 40A Swim)
AquaTrainer/Executive Trainer 40A
AquaTrainer 19DTAX Gold (20A Spa / 40A Swim)

IMPORTANT NOTE:

This guide is for standard installations where the wire run is 15m (50 ft.) or less. For longer wire runs, consult a qualified electrician.

2.4 NORTH AMERICAN GFCI INSTALLATION

Installation of the Siemens GFCI - Circuit Breaker, including ampere sizing and selection of conductor size and type, must be performed by a qualified electrician in accordance with the National Electrical Code, or the Canadian Electrical Code, and all Federal, State / Provincial and local codes and regulations in effect at the time of installation. Hydropool highly recommends the use of a new GFCI breaker for all of its products. Older GFCI's may have tripping issues.

NORTH AMERICA:

OPTION ONE:

AquaPlay
240 V / 60 HZ / 50A

240 VOLT SINGLE PACK WIRING

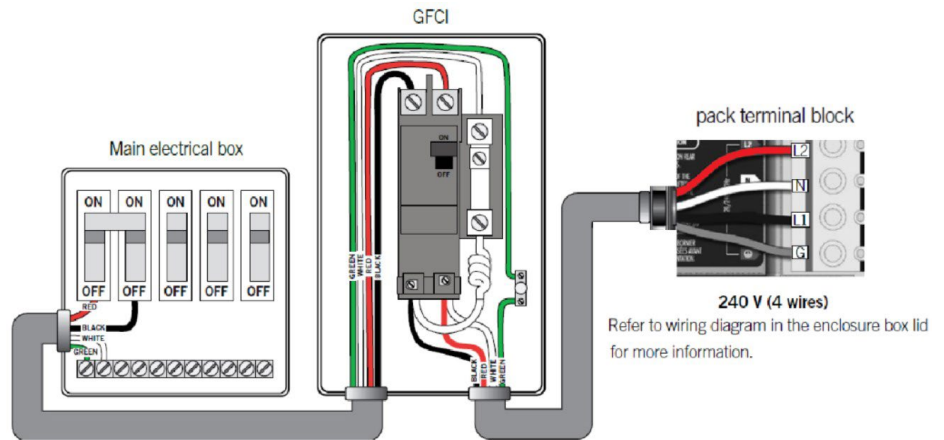

OPTION TWO:

AquaPlay
(with Additional Optional Heater only)
240 V / 60 HZ / 50A

240 VOLT TWO PACK WIRING

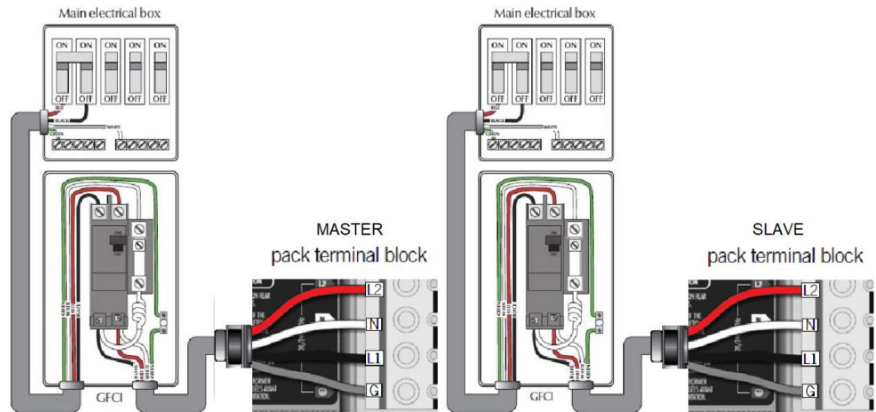

OPTION THREE:

AquaPlay
(with Additional Optional Heater only)
240 V / 60 HZ / 50A

240 VOLT TWO PACK WIRING (ALTERNATE WIRING OPTION USING A DISTRIBUTION BLOCK)

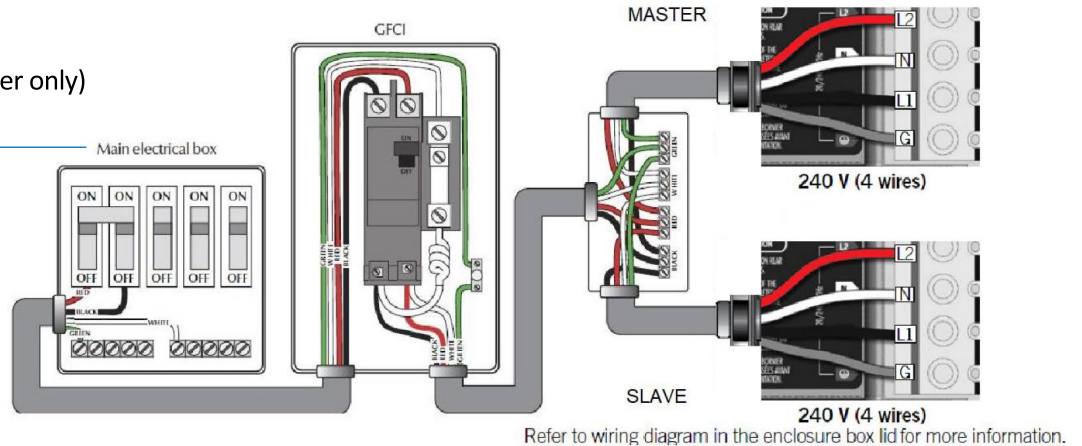

2.5 EUROPEAN R.C.D. INSTALLATION

IMPORTANT NOTE:

Installation of the Siemens R.C.D. - Circuit Breaker, including ampere sizing, GFCI Security Breaker and selection of conductor size and type, must be performed by a qualified electrician in accordance with National, Regional and Local Codes and Regulations in effect at the time of installation.

EUROPE:

AquaPlay 230 V / 50 HZ 40A

**230 VOLT 50 Hz
SINGLE PHASE
RCD WIRING
(MASTER ONLY)**

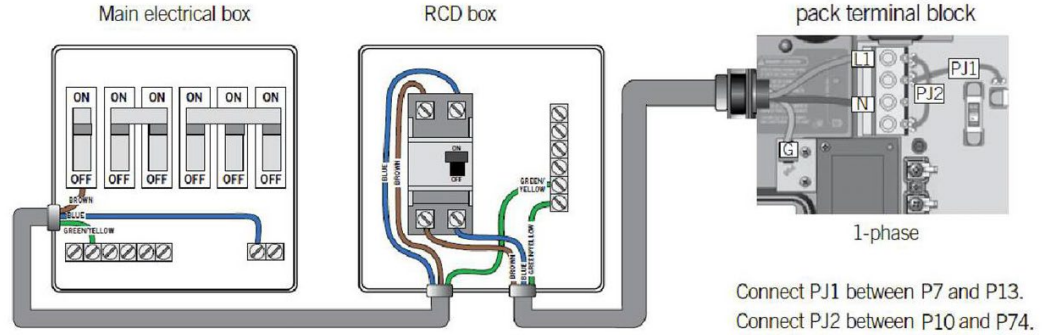

**230 VOLT 50 Hz
SINGLE PHASE
RCD WIRING
(DUAL SPA PACKS)**

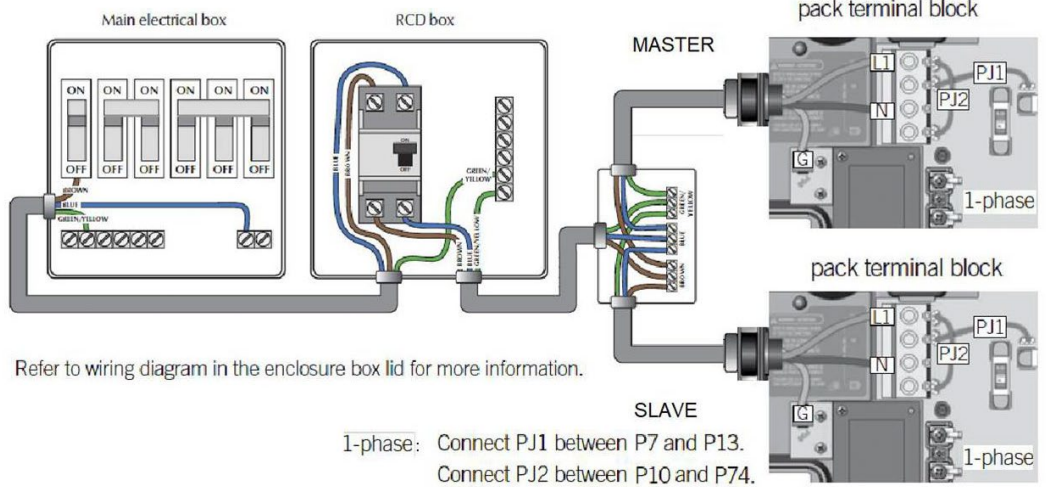

**230 VOLT 50 Hz
THREE PHASE
RCD WIRING
(DUAL SPA PACKS)**

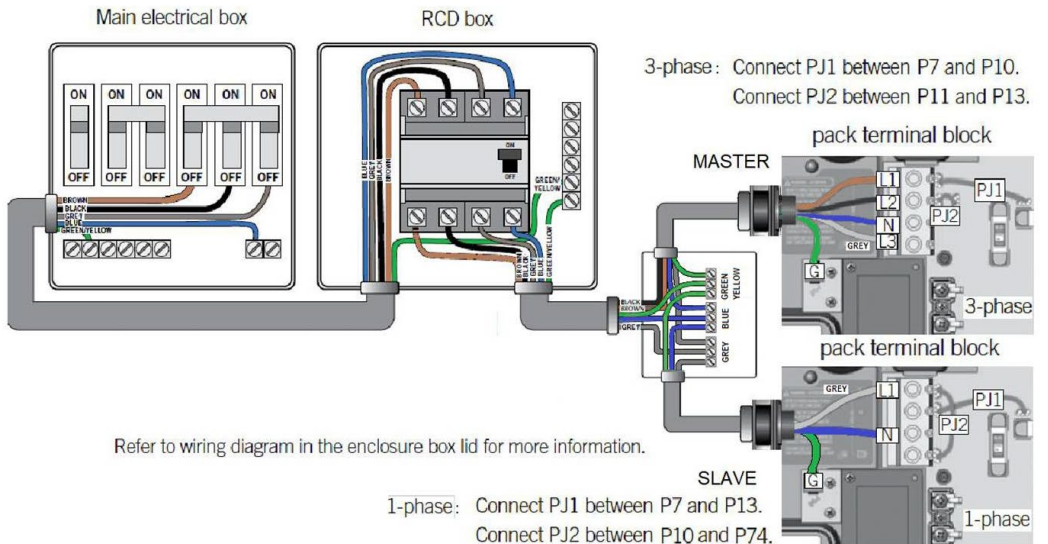

3 DELIVERY AND HANDLING CONSIDERATIONS

3.1 RETAILER DELIVERY

All Hydropool swim spas are shipped with a layer of protective foam wrap, plastic film and cardboard for added protection. Each swim spa is shipped from the factory strapped onto a wood skid. If your swim spa is to be delivered by your local Hydropool retailer, it will generally arrive on a flat bed truck or low profile trailer. Typically, the dealer will arrive with the necessary equipment to maneuver the swim spa from the truck. The swim spa can then be lifted by a crane into place.

3.2 DIRECT DELIVERIES

Like the retailer delivery, your swim spa will come wrapped and skidded the exact same way, however, your swim spa may arrive on a 48 ft. or 53 ft. common carrier closed box trailer. You can arrange the exchange at a local cross docking facility to a flatbed truck. The swim spa can then be lifted by a crane into place.

3.3 CRANE DELIVERIES

Most installations require the use of a crane. When a crane is used for lifting, place the straps under the swim spa, ensuring that the plumbing lines and fittings are not stressed and / or damaged and a spreader is used. The straps should be secured so that they will not slip in any direction and strap spreaders utilized to prevent undue structural side load on the swim spa shell.

3.4 FORK LIFT DELIVERIES

If you are removing the swim spa using a forklift, please make sure to use 8 – 10' / 2.5-3 m extended forks and pick up swim spa at the equipment end.

3.5 ROLLER DELIVERIES

Although it is recommended to install your swim spa by crane, it may be pushed along rollers by 10 to 12 able-bodied adults (see image).

If rollers are to be utilized, we recommend that at least six 4" / 10 cm diameter pipes, 10' / 3 m long, be placed under the shell to move it across a soft lawn, down a path, etc.

3.6 WARNINGS!

- Do not move or place the swim spa on its side
- Never lift or handle the swim spa by its plumbing
- the swim spas dry weight is in excess of 2,163 lbs / 981 kg.
- Please ensure lifting equipment is sufficient for the job. Manually lifting of the swim spa should be done with the proper manpower.
- We strongly recommend the installation to be done by a Hydropool Retailer.



4 BASE OF SUPPORT – LOAD SPECIFICATIONS

4.1 PREPARATION

Installation of a level concrete pad is mandatory.

Dig out and level the ground 20 - 30 cm (8 -12 in.) below your desired base level. Install 20 -25 cm (8-10 in.) of crushed stone. If there is a possibility that the pad could shift by freezing / thawing ground movement (such as in clay regions, and / or areas with high water tables) concrete footings extending below the frost line are recommended.

4.2 CONCRETE

Install 10-15 cm (4 - 6 in.) of poured concrete. The concrete support slab must be flat and level in-order to properly level the swim spa during installation. The concrete pad should be slightly larger than the dimensions for the swim spa, but it may be expanded even further for esthetic purposes or to allow more space for walking around the swim spa. Ensure that your concrete pad is capable of supporting 1220 kg / m² (250 lbs. / ft²). If the swim spa is purchased with steps your concrete pad should be made large enough to accommodate the size of the step.

4.3 SECOND LEVEL / BALCONY INSTALLATION

You must know the load tolerance and compare it to the weight of the swim spa filled with water and people. When in doubt, a load distribution assessment carried out by an engineer should be consulted, who can guarantee the best location choice. Ensure that your second level balcony is capable of supporting 1220 kg / m² (250 lbs. / ft²). While swimming, the motors and water flow in all swim spas generate vibrations that are directly transferred to the base on which the swim spa is installed. These can therefore be felt in lower levels. In this case, the support area must be properly engineered. Install a floor drain in the event there are any problems with the plumbing to sure that this water has a place to drain.

4.4 IMPORTANT: SWIM SPA FRAME SHIM INSTALLATION (APPLIES TO ALL INSTALLATIONS)

It is mandatory to have full support on all the gussets that are located on the side of the swim spa to keep it level and prevent bowing of the swim spa shell. Always make sure that the slab is perfectly flat before having the swim spa installed. You can use a garden hose and spray water on the slab and look for water puddles. If puddles form, you must re-work the surface, by adding self-leveling concrete or by buffing down the un-even area. The tolerance for the shim under the gusset is 1/8". Anything greater than that may cause structural issues. When the swim spa is installed on the slab locate the stickers or white lines on bottom of the swim spa frame to determine where to install the shim. The shims must be installed right under the gussets (the sticker or white line will appear in the center of the gusset, so it can be used as a guide to align the shim.

Note: There are 2 to 4 gussets per side depending on the model.

Simply attempt to insert the shim under the frame by hand and then gently tap on it with a hammer to make sure that it is secure under the frame. If the shim will not slide under by hand then no shim is need under that gusset. Proceed to the next gusset and repeat this process.

Then with a utility knife cut the shim flush to the end of the frame. When all the gussets are sitting properly on the ground, you can start filling the swim spa. Every swim spa will be delivered with a package of shims in case they are needed.

PLEASE NOTE: You may not require any shim, if your slab is perfectly flat. If the frame make perfect contact with the ground, you don't need to add the shim.



CROSS SECTION SIDE VIEW OF 2023 13FFP AQUAPLAY SWIM SPA INSTALL ABOVE GROUND

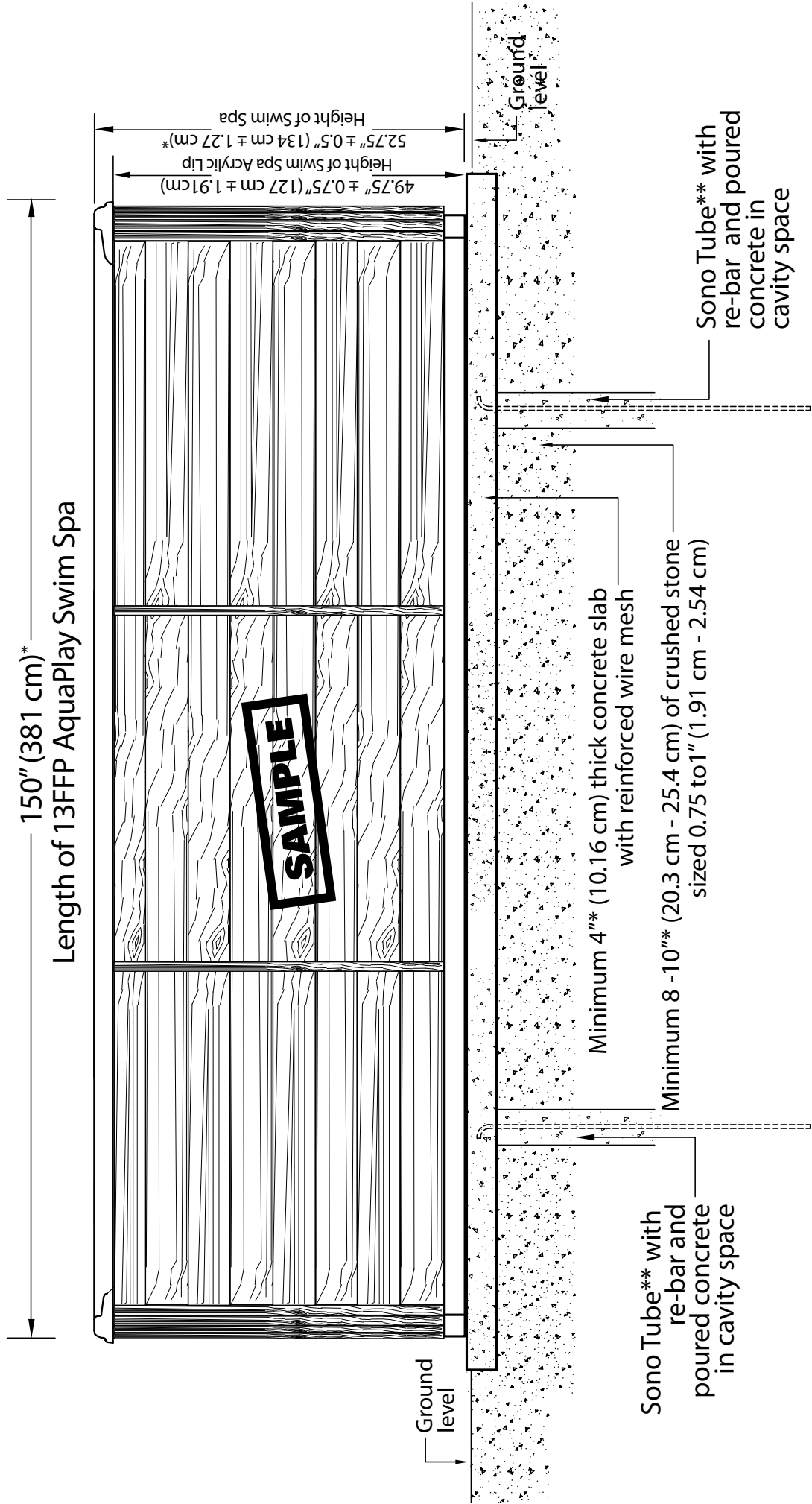

* Hydropool Inc. can not be held liable for the accuracy of this drawing. It is purely provided as a guide only. As each Swim Spa installation has its own set of challenges and variations due to materials used and location of the install.
 ** Sono Tubes only required in installations that are in regions that experience freezing and thawing.

CROSS SECTION TOPSIDE VIEW OF 2023 13FFP AQUAPLAY SWIM SPA INSTALL ABOVE GROUND

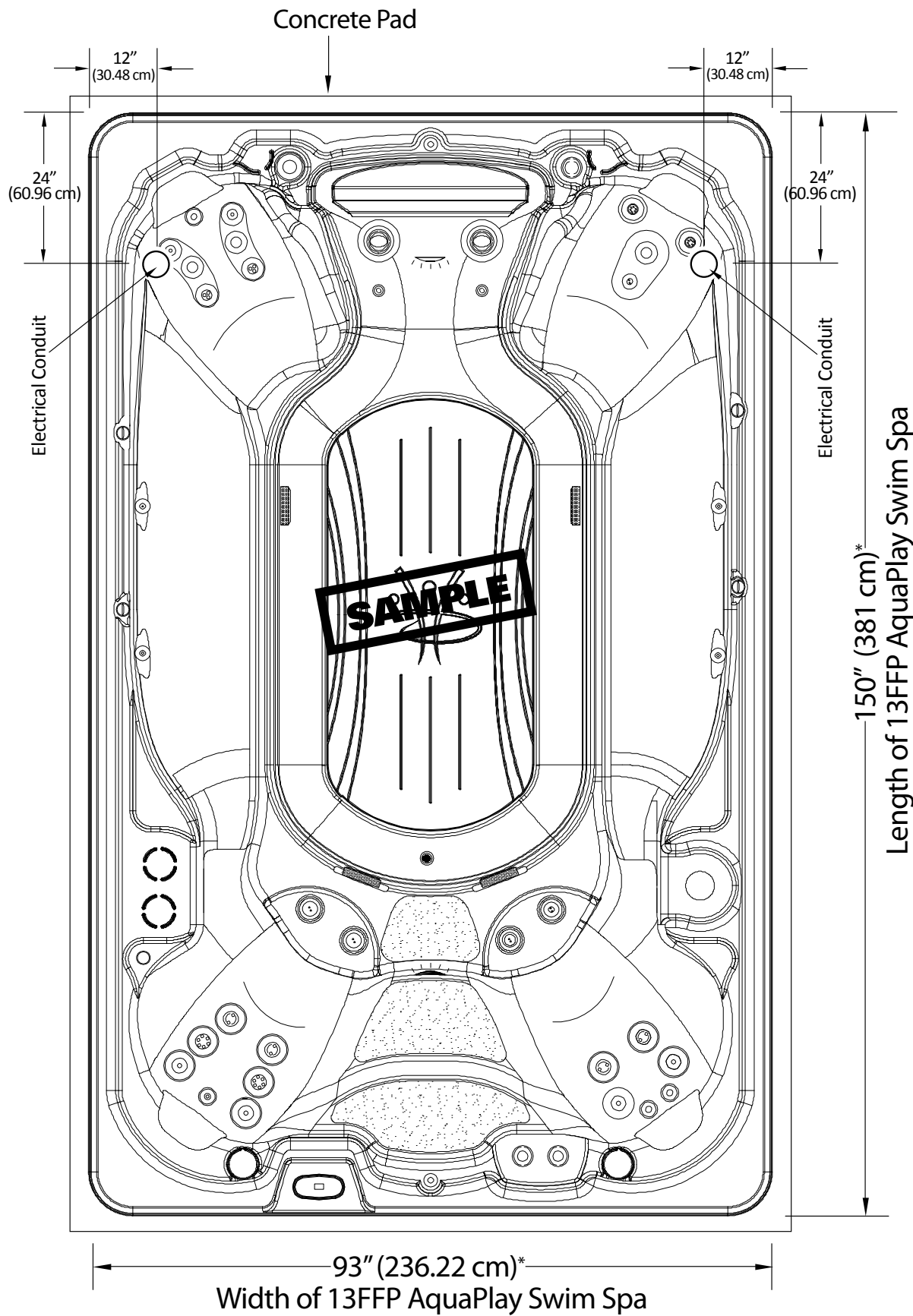

* HydroPool Inc. can not be held liable for the accuracy of this drawing, it is purely provided as a guide only.
As each Swim Spa installation has its own set of challenges and variations due to materials used and location of the install.
** Sono Tubes only required in installations that are in regions that experience freezing and thawing.

5 BELOW GRADE OR PARTIAL IN GRADE INSTALLATIONS

5.1 BACKFILLING EXCLUSION

Hydropool will void any warranty of swim spas that are back-filled.

5.2 EXCAVATION

Call before you dig! Please make sure you have any permits in place that are required from your municipality.

5.3 VAULT/BUNKER SPECIFICATIONS

When recessing the swim spa all or part way below ground level, a concrete base along with a concrete retaining wall to hold back the earth is required. This forms a Vault or 'bunker', in which the swim spa is placed.

5.4 BASE OF SUPPORT

It is necessary that a concrete base be poured level and reinforced in order to support the swim spa. In addition, if you are in an area that experiences freezing and thawing concrete footings should be added as outlined in section 4 of this guide.

5.5 CRAWL SPACE

It is recommended leaving a 24 in. (61 cm) wide crawl-space around the entire unit to ensure adequate accessibility on the all sides for service access. At the Equipment end it is recommended to have a 3 ft. / 90 cm crawl space for work space.

5.6 GROUND WATER

The Vault will be the lowest part of your backyard and therefore good drainage is essential. A properly designed drain system and sump pump complete with a float switch should be constructed as part of the crib and should be located at the equipment end of the Swim Spa. This should prevent flood damage from ground water that may enter the crib.



CROSS SECTION TOP VIEW OF 2023 13FFP AQUAPLAY SWIM SPA WITH CABINET INGROUND...

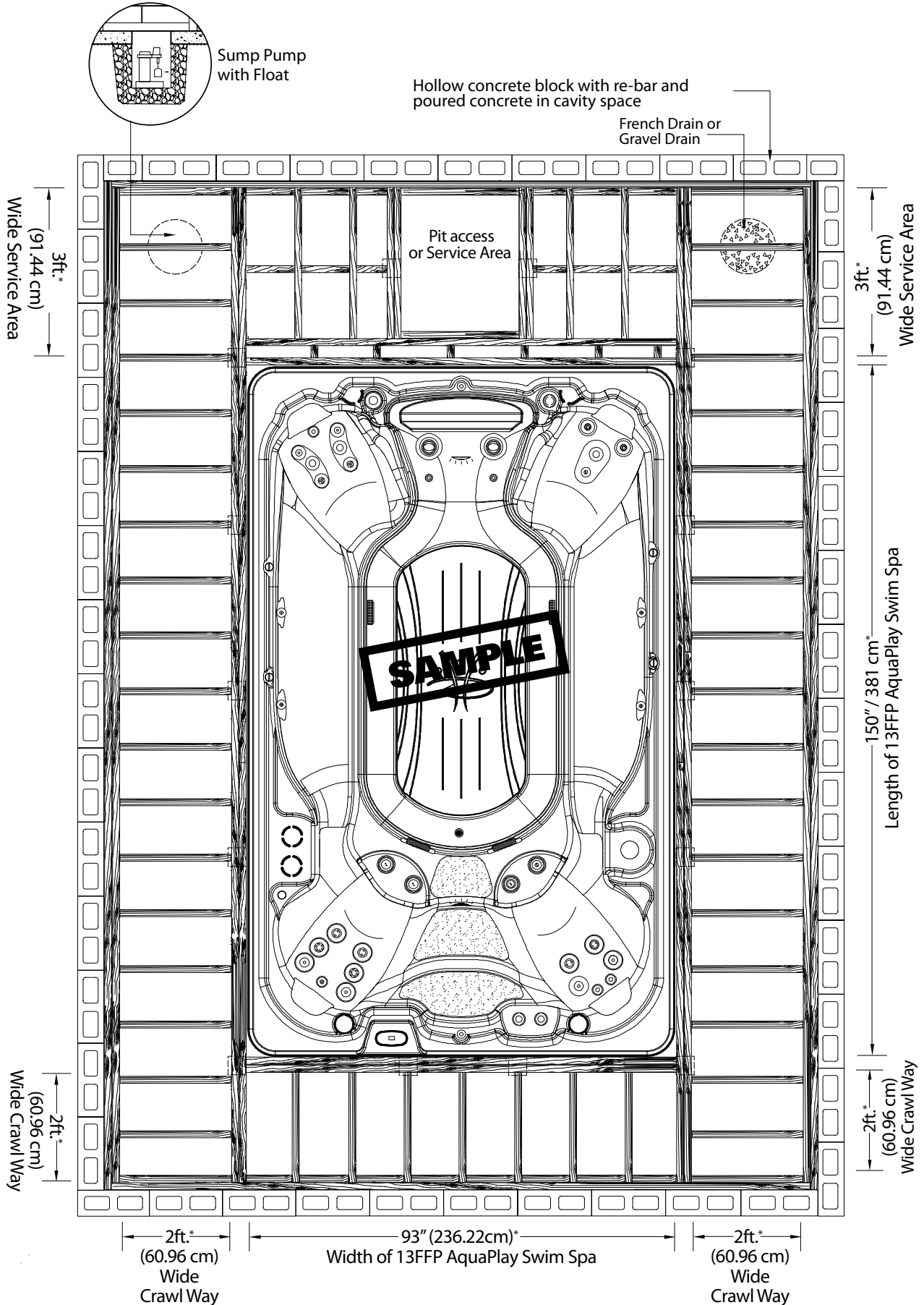

* Hydrex Inc., can not be held liable for the accuracy of this drawing, it is purely provided as a guide only. As each Swim Spa installation has its own set of challenges and variations due to materials used and location of the install.
 ** Sono Tubes only required in installations that are in regions that experience freezing and thawing.

CROSS SECTION END VIEW OF 2023 13FFP AQUAPLAY SWIM SPA WITH CABINET FULL INGROUND INSTALLATION...

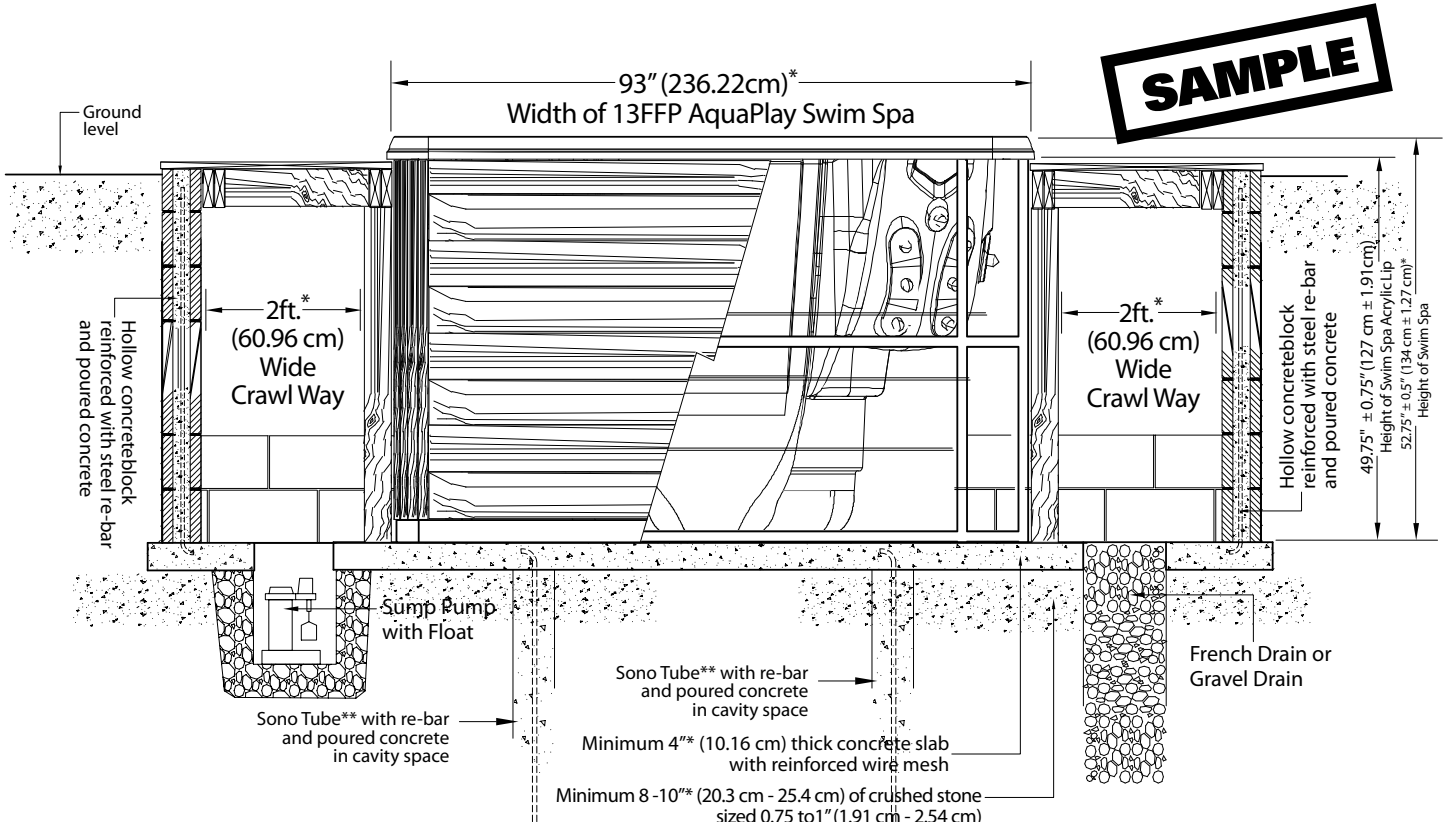

* Hydropool Inc., can not be held liable for the accuracy of this drawing, it is purely provided as a guide only.
As each Swim Spa installation has it own set of challenges and variations due to materials used and location of the install.
** Sono Tubes only required in installtions that are in regions that experience freezing and thawing.

CROSS SECTION END VIEW OF 2023 13FFP AQUAPLAY SWIM SPA WITH CABINET PARTIAL INGROUND INSTALLATION...

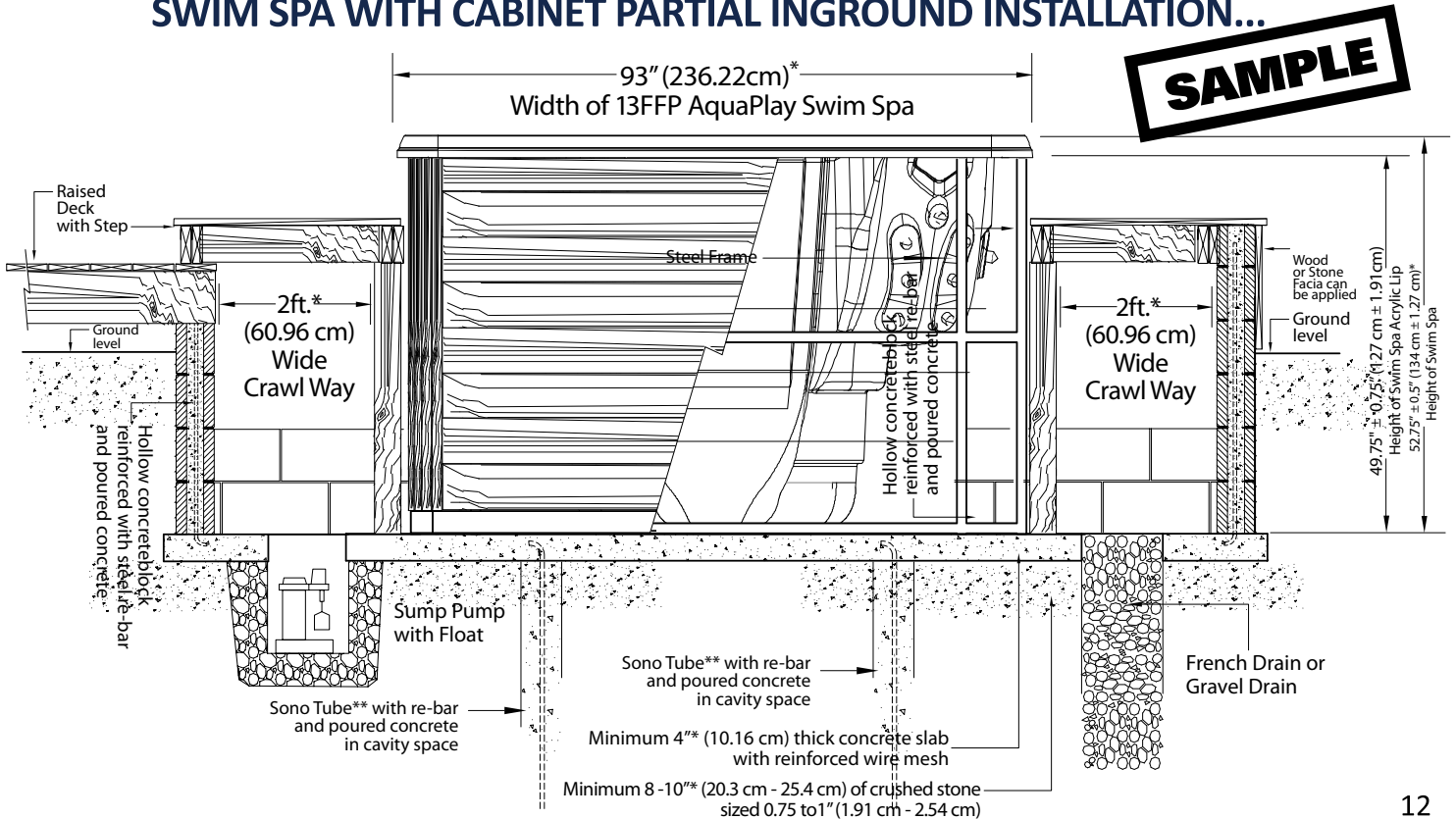

CROSS SECTION SIDE VIEW OF 2023 13FFP AQUAPLAY SWIM SPA WITH CABINET INSTALL INGROUND...

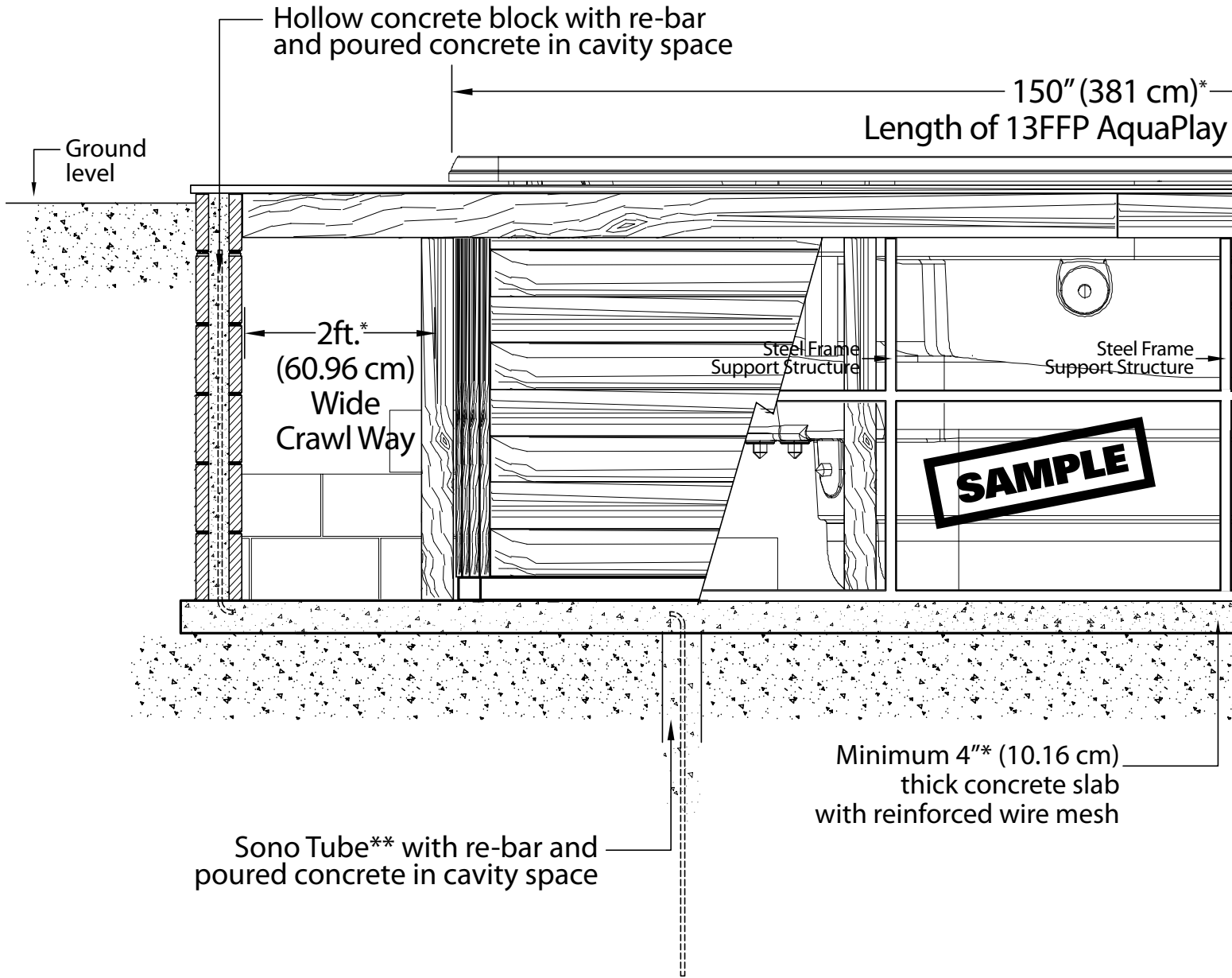

NOTES:

NOTE:
Support posts for the Access Hatch sit between the French Drain and Sump Pump

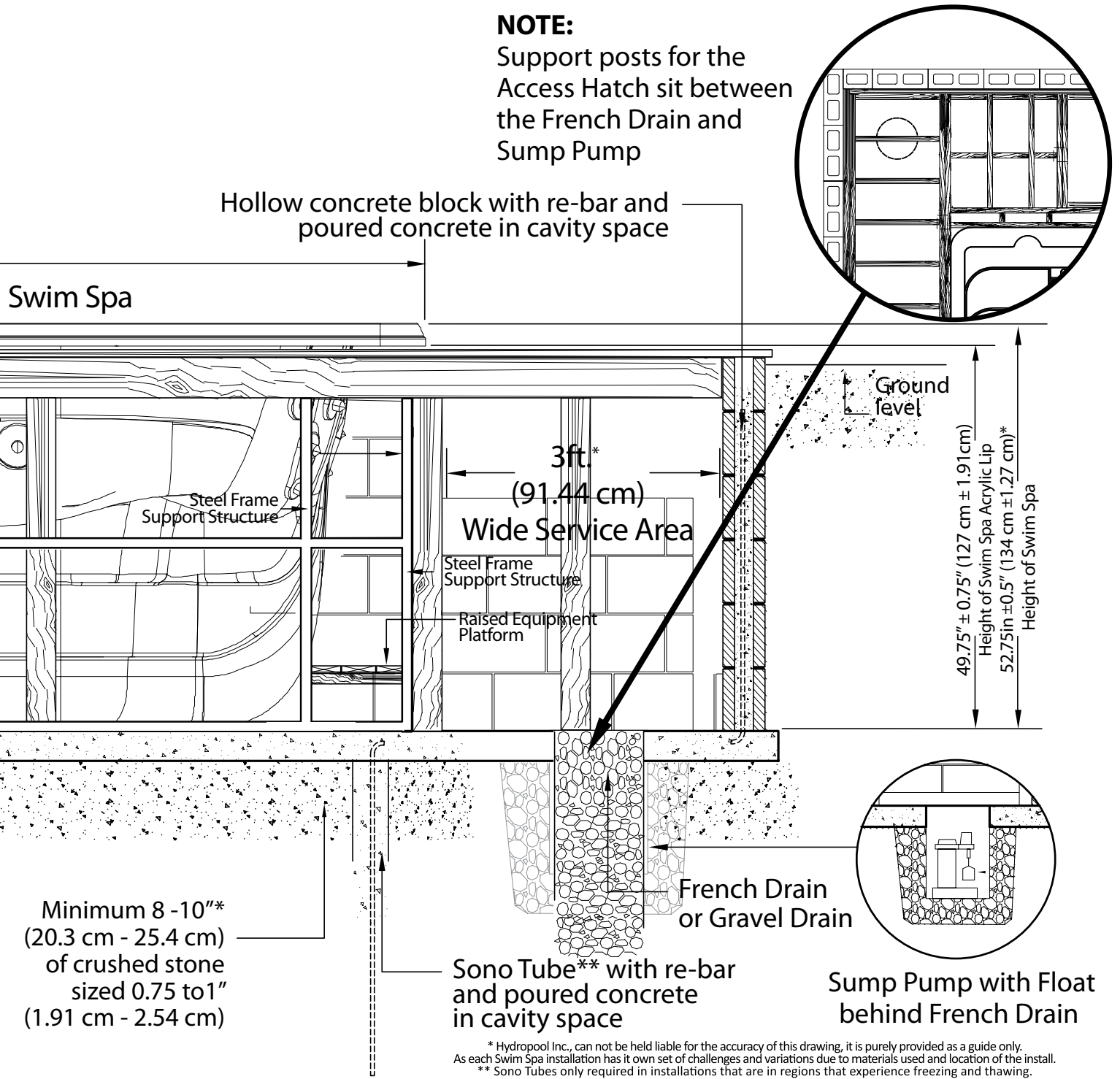

* Hydropool Inc., can not be held liable for the accuracy of this drawing, it is purely provided as a guide only. As each Swim Spa installation has its own set of challenges and variations due to materials used and location of the install.
** Sono Tubes only required in installations that are in regions that experience freezing and thawing.

NOTES:

5 BELOW GRADE OR PARTIAL IN GRADE INSTALLATIONS WITH CABINET (CONT'D...)

5.7 SERVICE ACCESS

Future service must be considered at the time of design and installation. You must be able to access all sides and areas of your swim spa. Difficult access will result in supplemental service labour charges not covered by the factory warranty. Consider easily removable deck materials.

5.8 WATER TEST

During shipping and handling some of the components may have shifted. Please ensure the swim spa is tested for 48 hours before you prepare the installation of the surrounding/finish deck around your swim spa. Even though all units are tested in our plant, some transport/site handling damage can occur and we suggest you make sure the swim spa is perfectly waterproof before finalizing your installation.

5.9 OVERALL SUPPORT

Your Hydropool Swim Spa is equipped with a factory installed load support substructure, which distributes the weight of the water over the entire foot print area of the swim spa. The supporting floor must be even and level. Although the lip of the swim spa must be supported to ensure it remains level, **NEVER SUSPEND** a swim spa from a deck or floor by the outer acrylic edge, as this will lead to product damage and/or serious personal injury.

5.10 INSULATION

It is important to create a well-insulated vault when installing a swim spa in ground. This can be done a couple of ways:

- 1) Use insulated concrete forms when pouring the walls of the vault. This will accomplish two things, one it will provide the wall support needed to build a deck and two it will give the insulation required to keep the running costs to a minimum
- 2) After installing the concrete block for the walls of the vault, add Styrofoam Blue insulation or Thermal Shield blanket to the interior walls to create well insulated area

5.11 SET UP AND ASSEMBLY

Set-up of your swim spa will vary depending on whether you have purchased an AquaPlay, AquaSport or AquaTrainer model. Once your swim spa is set into place, you can adjust the posts for levelling the swim spa and the equipment is already connected.

5.12 EQUIPMENT PROTECTION

The equipment must be located in an area where it will remain dry and will not be exposed to rain, snow or ground water. When your swim spa is to be installed above ground, the factory cabinet is designed for both protection, insulation and accessibility. When your swim spa is to be installed fully or partially in the ground it is necessary that it be installed in an area that is dry, protected from the elements, has proper ventilation, and is easily accessible for service.

6 SERVICEABILITY, ACCESSIBILITY AND PROTECTION

6.1 EQUIPMENT PROTECTION

The equipment must be located in an area where it will remain dry and will not be exposed to rain, snow or ground water. When your swim spa is to be installed above ground, the factory cabinet is designed for both protection, insulation and accessibility.

When your swim spa is to be installed fully or partially in the ground, it is necessary that the equipment be installed in an area that is dry, protected from the elements, has proper ventilation, and is easily accessible for service.

6.2 IN GROUND INSTALLS

Note that the equipment is supplied on a composite support equipment platform, if you are installing below grade, always ensure that the equipment is mounted on an optional raised base or platform to prevent potential water damage to the motors, equipment or controls.

6.3 SERVICEABILITY

Ensure that access to the equipment, and the working area around the equipment, is large enough to accommodate a service person.

6.4 REMOTE EQUIPMENT

If ordered with remote equipment, the equipment should be located as close to the swim spa as possible to maximize jet performance, water lines need to be equal and as straight as possible. Never install the equipment above the water level as it will prevent priming and minimize flow rate performance. Remote equipment must be installed with protection from the elements in an enclosure. Failure to do so could result in a failed electrical inspection.

6.5 RODENT PROTECTION

For any installation, protection from rodent infestation is imperative. If the swim spa with cabinet is being installed and as long as your concrete pad is level there should be no need for any further protection against rodents. However, if the swim spa is being installed in ground it is important to take the precautions required to make sure rodents don't make a home in your vault area. Protect access points and repair if needed.



6.2 In Ground Installs



6.3 Serviceability

7 FILLING AND DRAINING

7.1 GENERAL CONSIDERATIONS

- Be sure to check with your local by-laws regarding disposal of waste water from your swim spa
- Avoid filling with soft or well water
- Filling through the skimmer is optimal for reducing / eliminating any air locks

7.2 INDOOR INSTALLATIONS

There will be water lost in the swim spa due to splash out, hence, you will need to top up the swim spas periodically. When building the room for the swim spa consider plumbing a water tap location nearby to facilitate filling. You will need to drain your swim spa periodically, so please make sure to install a drain in the room that can handle the volume of water in a swim spa.

7.3 OUTDOOR INSTALLATIONS

Draining and Filling is easy with an outdoor swim spa. Use a garden hose to fill the swim spa and use the hose provided to drain it. Do not plumb a permanent fill or drain line to the swim spa if you are in an area where the temperature drops below freezing.

8 AUXILIARY HEATING OPTIONS

8.1 GAS HEATERS

There are a number of different ways to heat your swim spa using the Auxiliary Heating Option, the most common is using a gas heater. The most common size used for our swim spas is 100,000 BTU / 30 KWH .

8.2 OTHER METHODS ARE PROPANE HEATERS, GEOTHERMAL HEATING AND SOLAR HEATING.

Please consult your local retailer for more information on these alternative methods to heat your swim spa.

8.3 AUXILIARY BYPASS OPTION

Installing the Hydropool optional Auxillary Bypass can help to facilitate any of the above installation options.





9 HUMIDITY-VENTILATION & OTHER INDOOR CONSIDERATIONS

9.1 HUMIDITY

All swim spas emit quantities of moisture into the surrounding air. In fact, evaporation will increase proportionally with the difference between the temperature of the surrounding air and of the water. To prevent this from happening, heat the air to more than 26° C / 79F if the swim spa is located inside a dedicated room. This will make bathing more comfortable and will limit evaporation.

9.2 VENTILATION

The swim spa room should have a window, and a humidistat controlled exhaust fan for ventilation. Some rooms may require a mechanical air extraction system in order to potentially dehumidify the air during and after swimming. Consult your local Building Codes.

9.3 COVERS

If you decide to purchase the hardcover put it on when you are not using the swim spa. This will reduce evaporation and limit your water heating costs. Use your hard cover as much as possible or purchase a floating summer cover for easier use.

9.4 FLOOR DRAINAGE

It is very important to install a non-slip surface/tile for your indoor installation as the floors will become very slick with water on it. It is also important to install floor drains around the swim spa to help with the splashout.

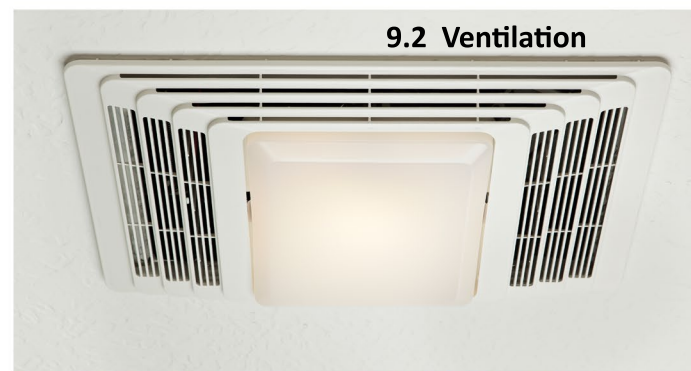

10 HARDCOVER STORAGE

10.1 HARDCOVER

If your swim spa comes with a Hardcover, make sure to prepare storage area for when the swim spa is being used. The swim spa cover comes standard in a number of sections that are velcroed together depending on the size.

10.2 POOL SHED

Storing the cover in a pool shed is the most common way to keep the cover safe and out of sight.

11 BY LAWS AND DISCLAIMERS

11.1 BUILDING CODE

Contact your local building code department to determine if a building permit is necessary and for information on applicable bylaws (distance from property lines, buildings, fencing requirements, etc.)

11.2 EXCAVATION

Prior to any excavation contact your local gas, electric, and cable company to ensure that there are no underground lines.

11.3 RECOMMENDATIONS AND PREPARATION GUIDELINES

This an integral part of your order, and it contains the recommendations and guidelines for preparing your work site. It is important that you take the time to carefully read this document in your capacity of Project Manager.

11.4 PROFESSIONALS

ATTENTION: You must enlist professionals to complete the preparation work, and provide a copy of this document to each of them. This work will be carried out under their sole responsibility. Furthermore, if you plan to use a delegated Project Manager, you must also provide him or her with this document, and we recommend that you ensure its proper care in order to guarantee compliance with the regulations. Of course, we are available to answer all of your questions regarding the installation of your spa. The specifications described in this document are intended for professionals and are for informational purposes only. The Project Manager must consider these specifications while performing the work in accordance with the regulations and standards for the specific model.

11.5 SUNLIGHT

DO NOT leave the swim spa out in the sunlight for extended periods of time with no water. The cabinet may bend slightly if exposed to sunlight for extended periods of time or the acrylic may crack.

CAUTION: Covers must be kept on the swim spa at all times when unit is drained or winterized. Direct exposure to sunlight can damage plastic parts and interior space, jets, or any interior components. Damage caused by exposure to sun will not be covered under warranty.

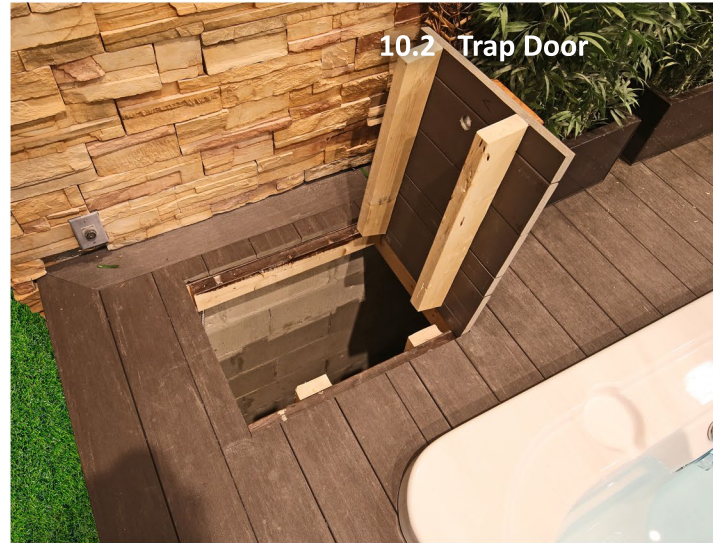

2023 HYDROPOOL AQUAPLAY COLLECTION

13FFP Model Swim Spa

INSTALLATION GUIDE



HYDROPOOL
hot tubs • swim spas

THE WATER IS CALLING



EFFECTIVE DATE: January 1, 2023 *(supersedes all others)*

CAUTION: THIS GUIDE IS FOR REFERENCE ONLY! All installations must follow local electrical and building codes. Please consult your local business and planning division for your codes in your area.

HYDROPOOL INC. WILL NOT BE RESPONSIBLE FOR ANY ERRORS IN INSTALLATIONS OR CODE INFRACTIONS.